

 **SCHONBEK** | 1870









CHANTANT CH1801N- __ _ O



THIS DESIGN IS THE PROPRIETARY
TRADE DRESS/TRADEMARK OF
W SCHONBEK LLC.



5 Lights
Diameter: 21"
Height: 17"
Hanging Weight: 26lbs.

 **SCHONBEK** | 1870

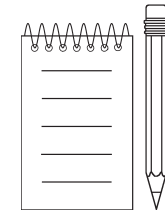
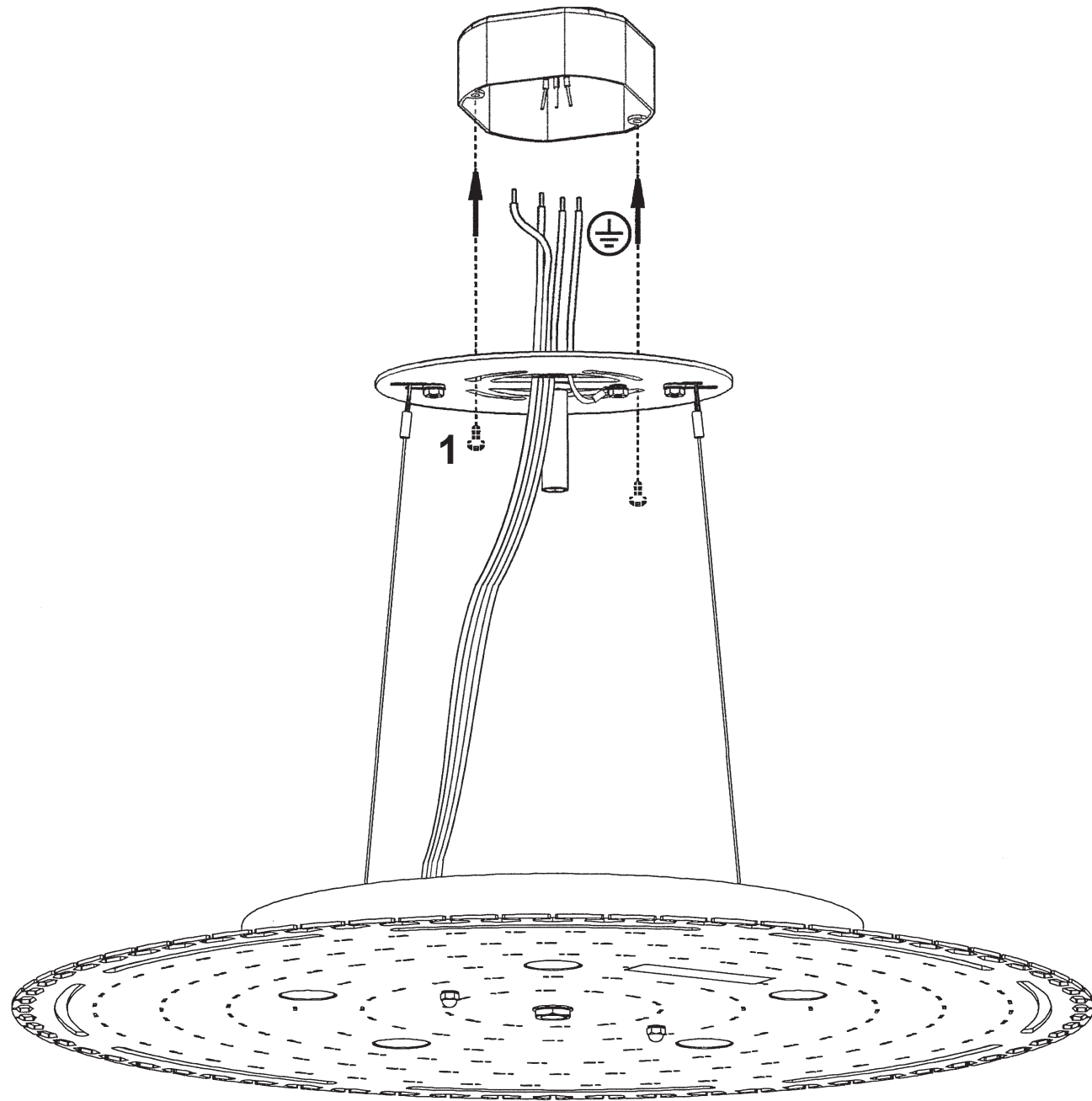
			S					
MAX 35 W	110-120 V							

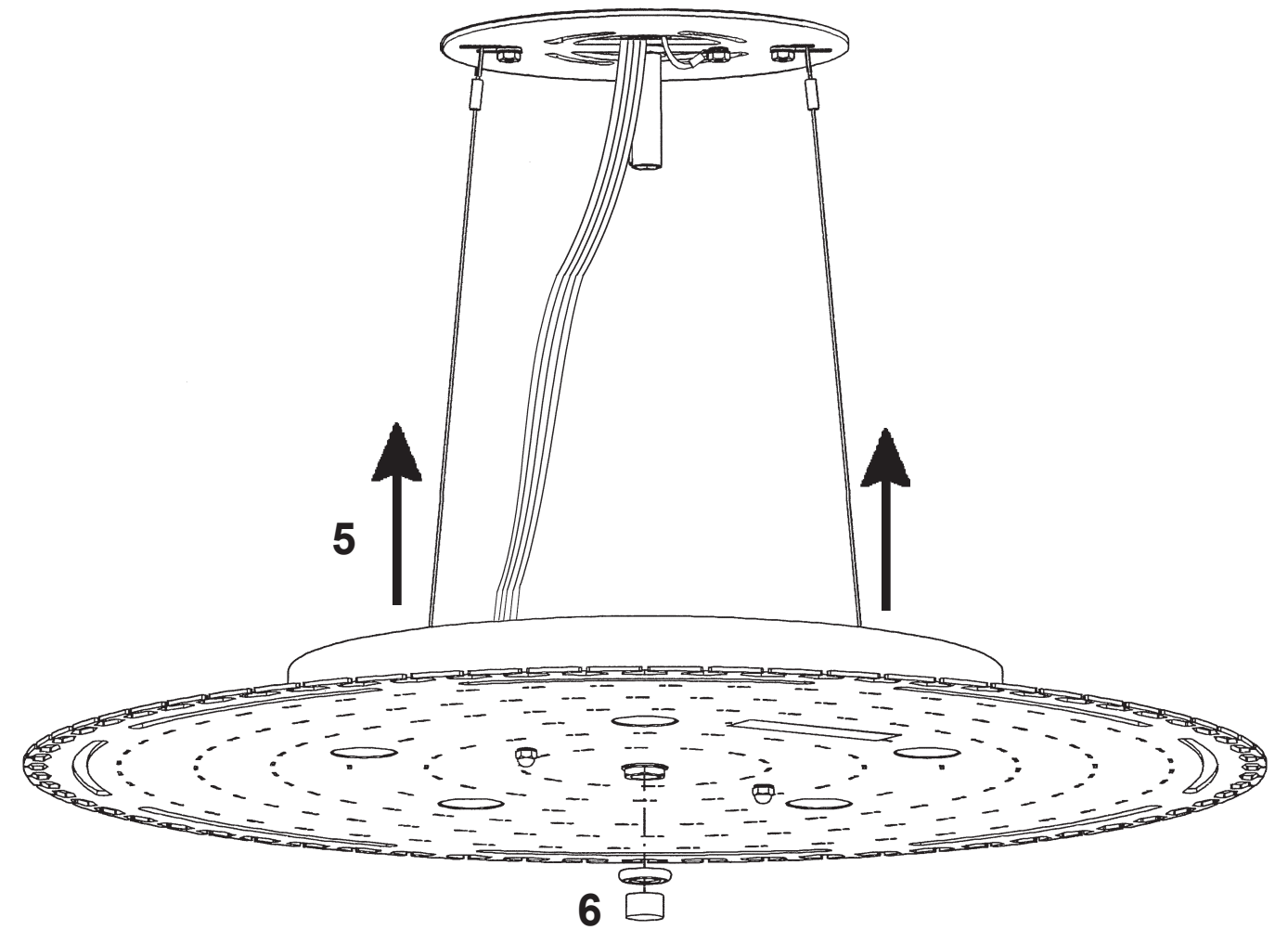
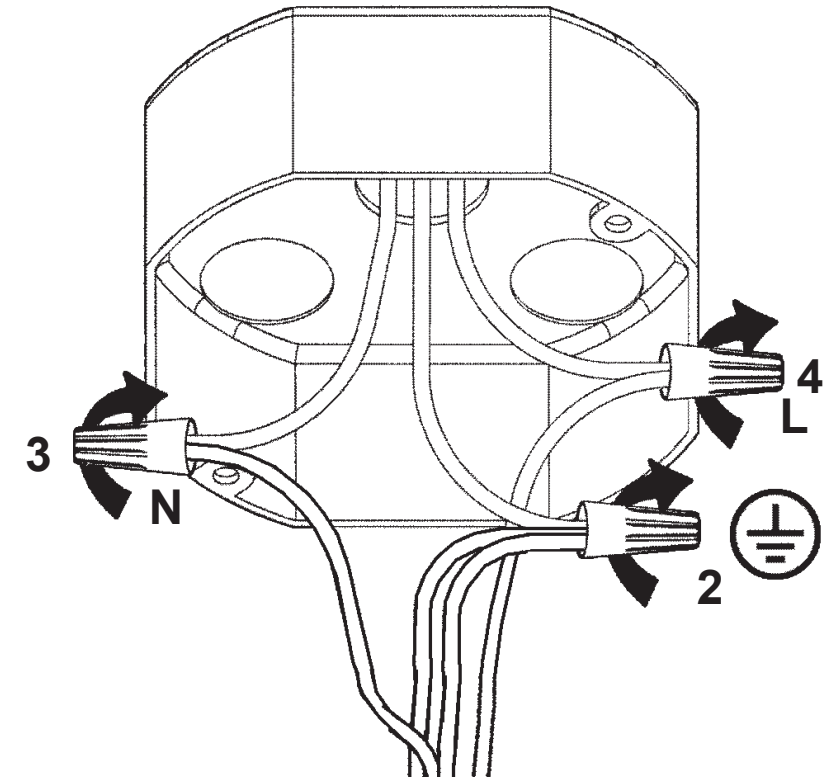
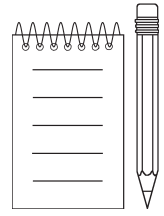

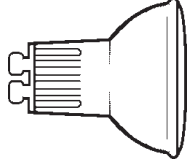

5 X  : GU10 35W MAX 

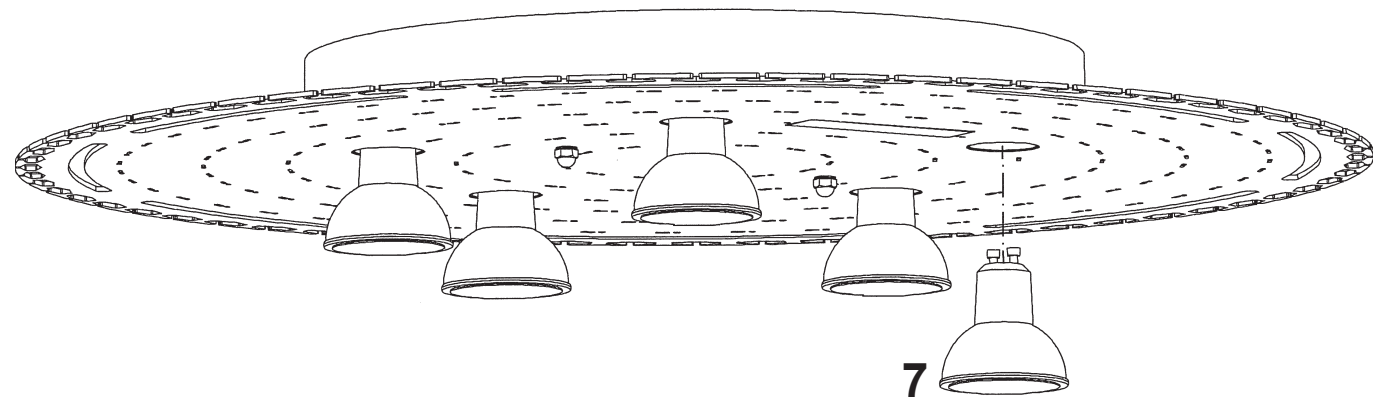

7

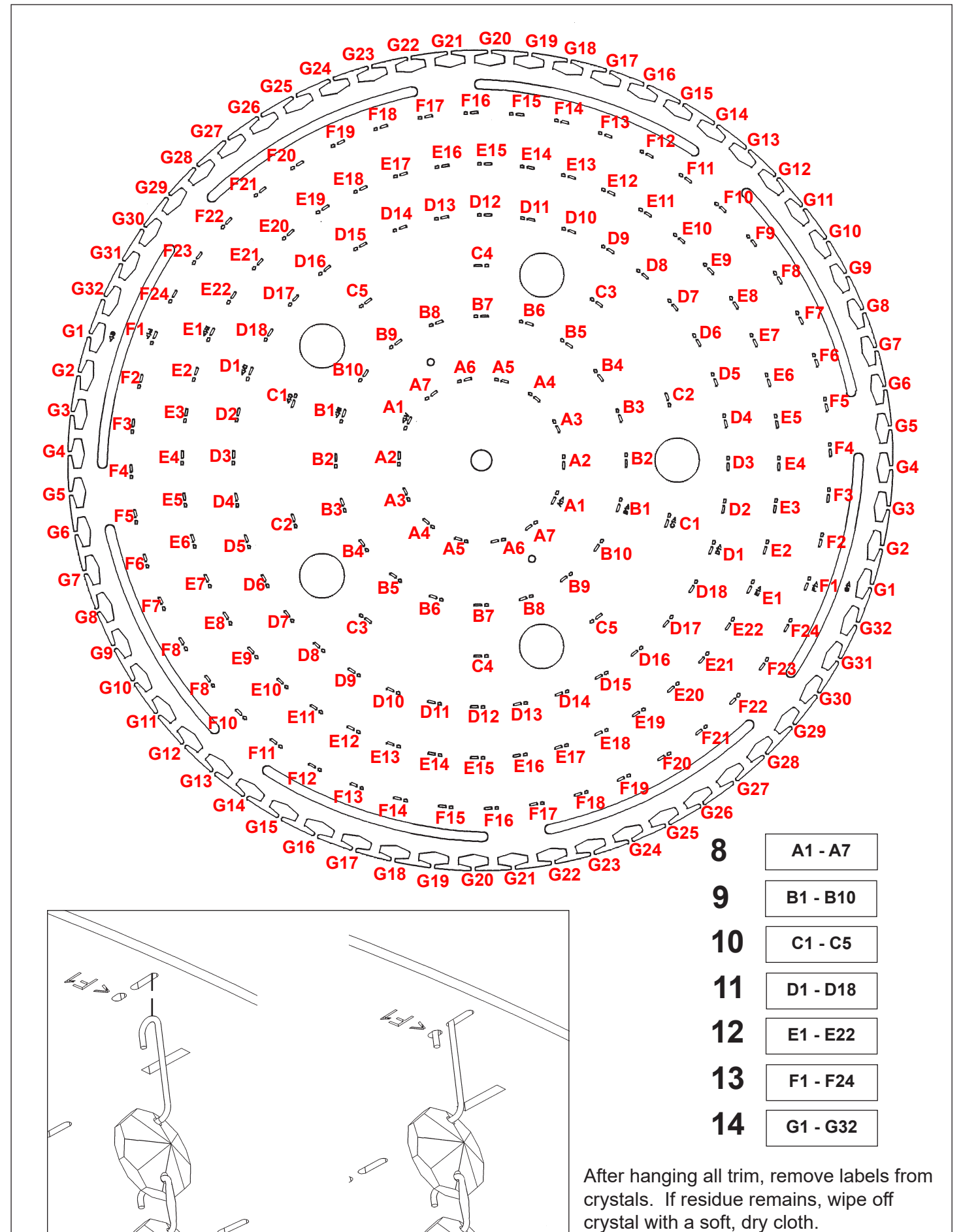

After hanging all trim, remove labels from crystals. If residue remains, wipe off crystal with a soft, dry cloth.

 **SCHONBEK** | 1870



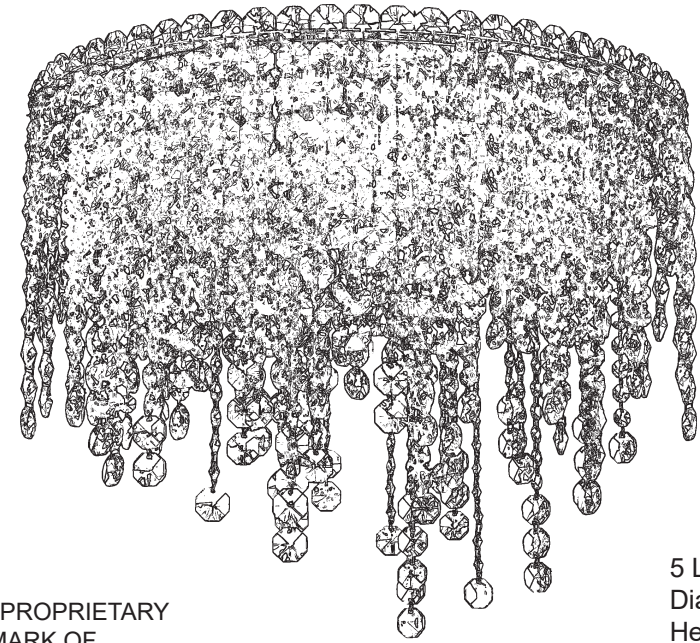





CHANTANT CH1801N-__ _R



THIS DESIGN IS THE PROPRIETARY
TRADE DRESS/TRADEMARK OF
W SCHONBEK LLC.



5 Lights
Diameter: 21"
Height: 17"
Hanging Weight: 26lbs.

 **SCHONBEK** | 1870

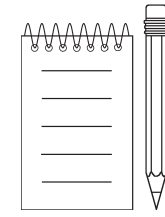
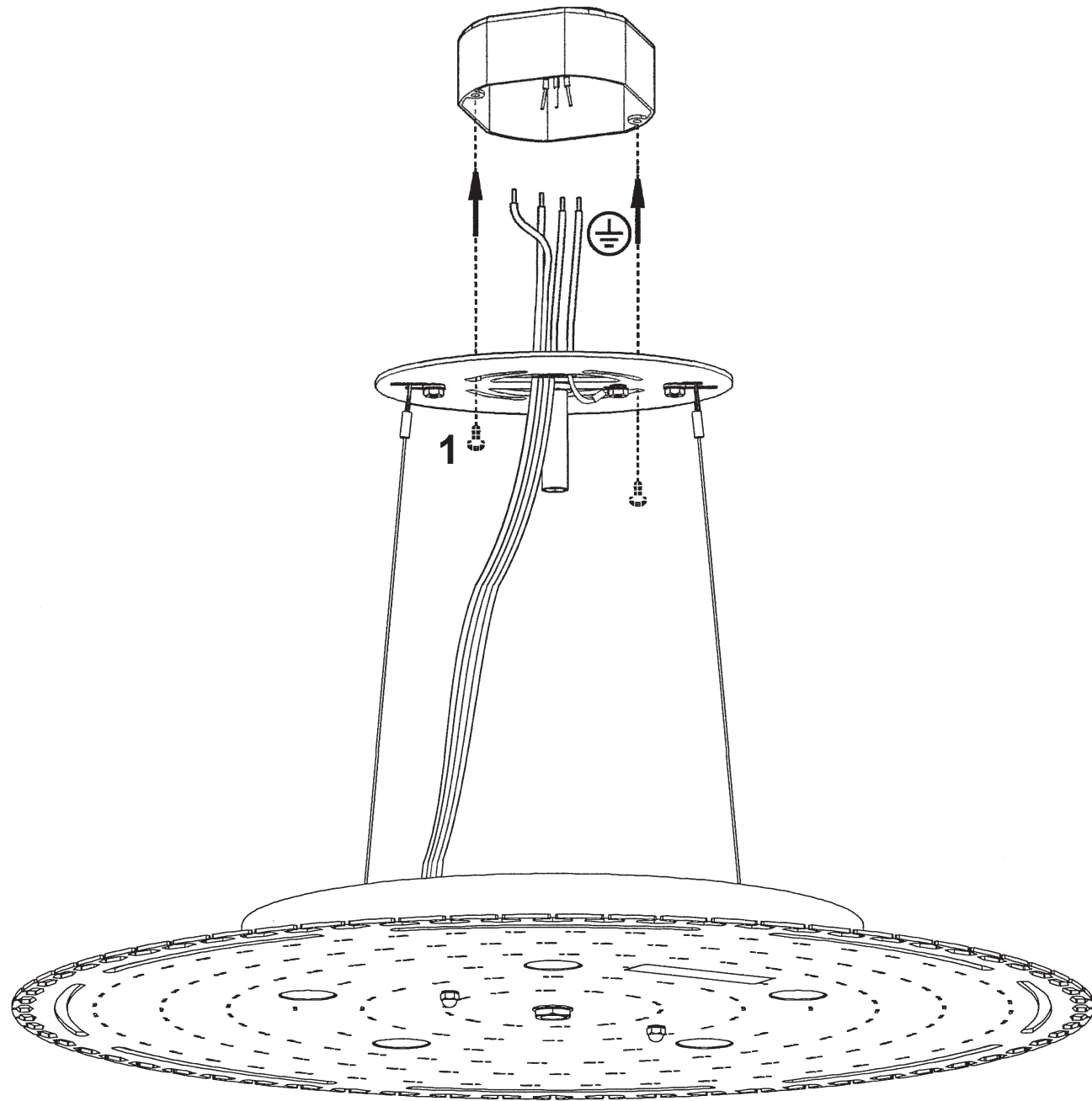
			S					
MAX 35 W	110-120 V							

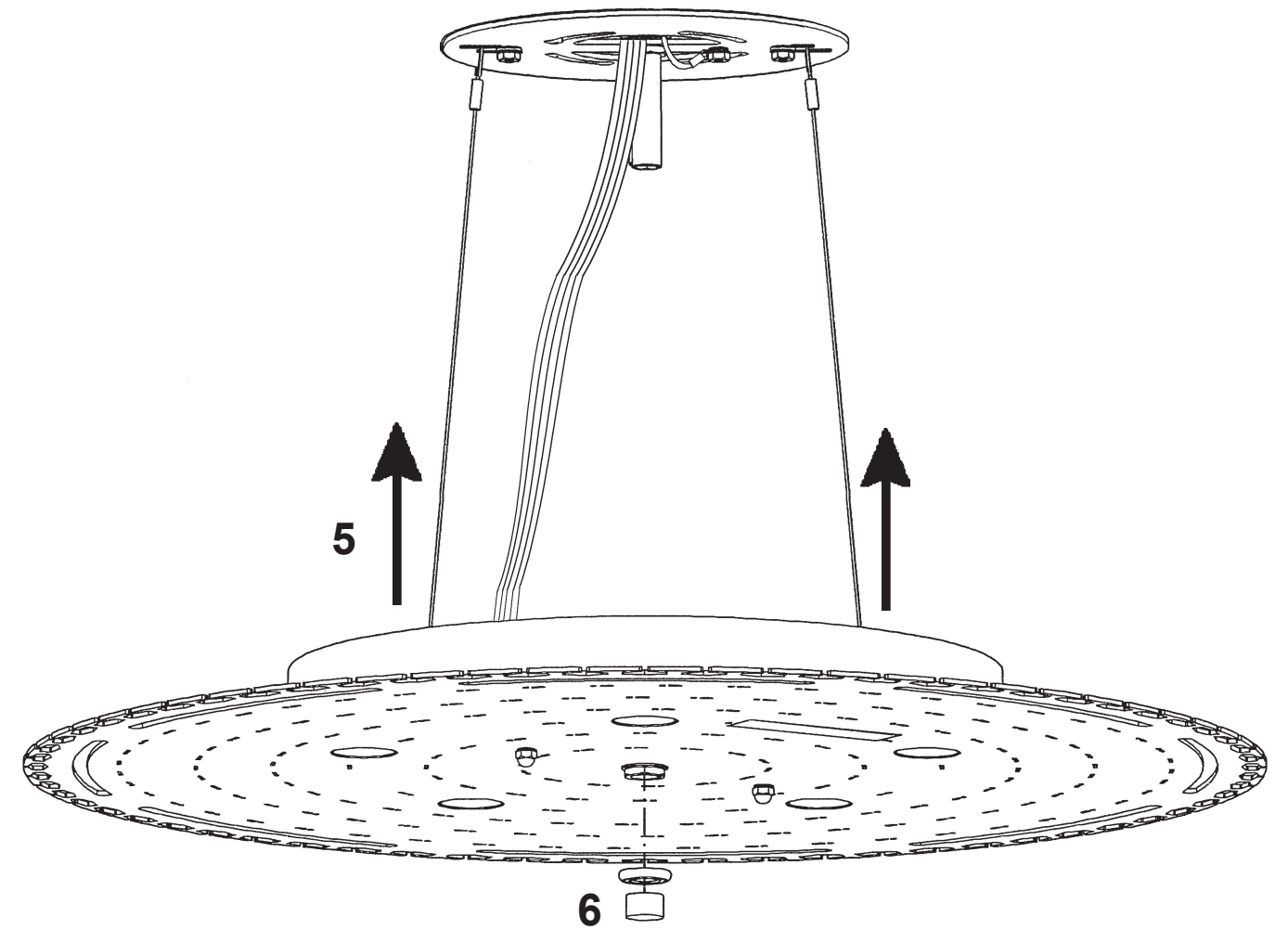
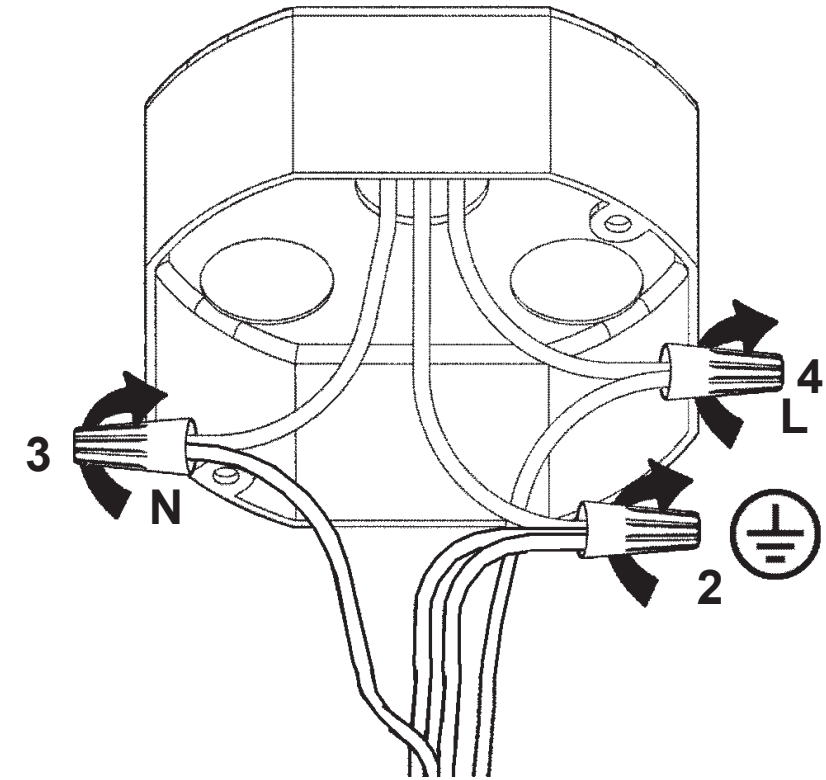
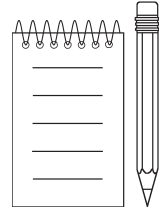

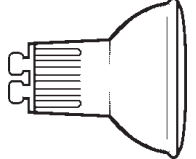

5 X  : GU10 35W MAX 

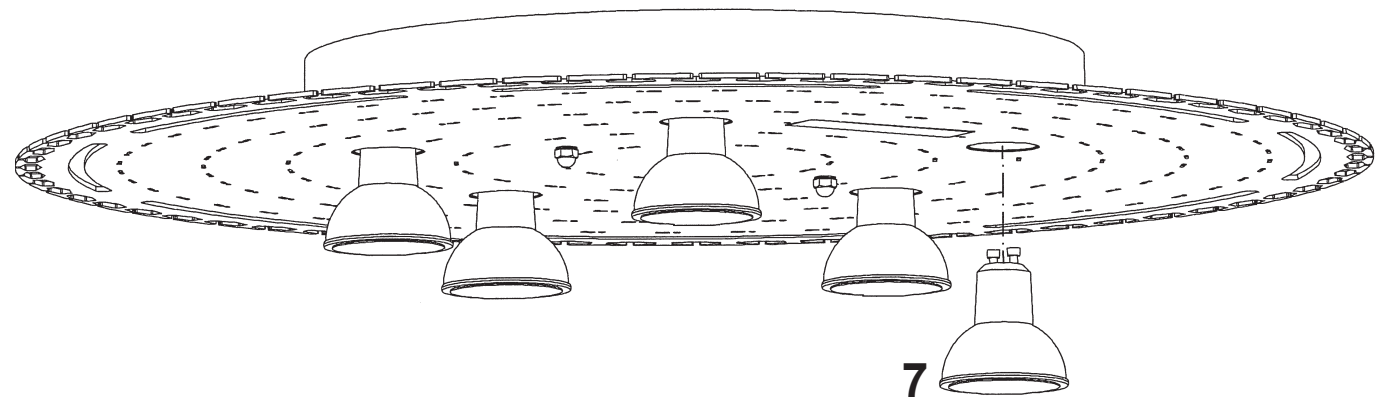

7

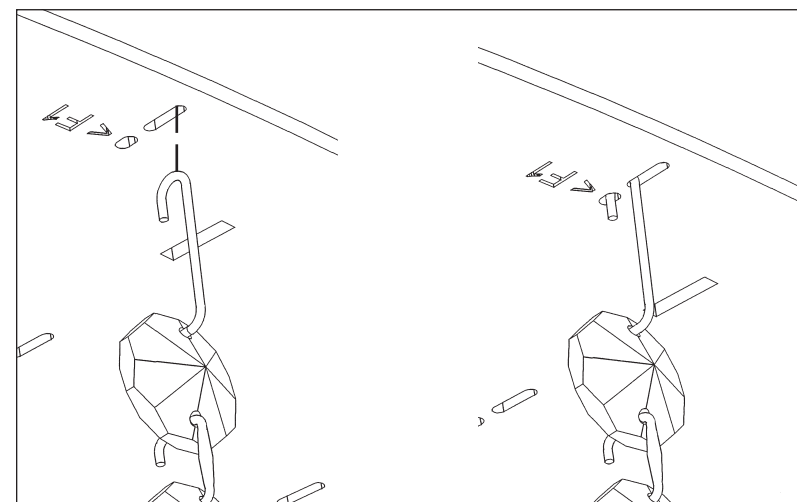
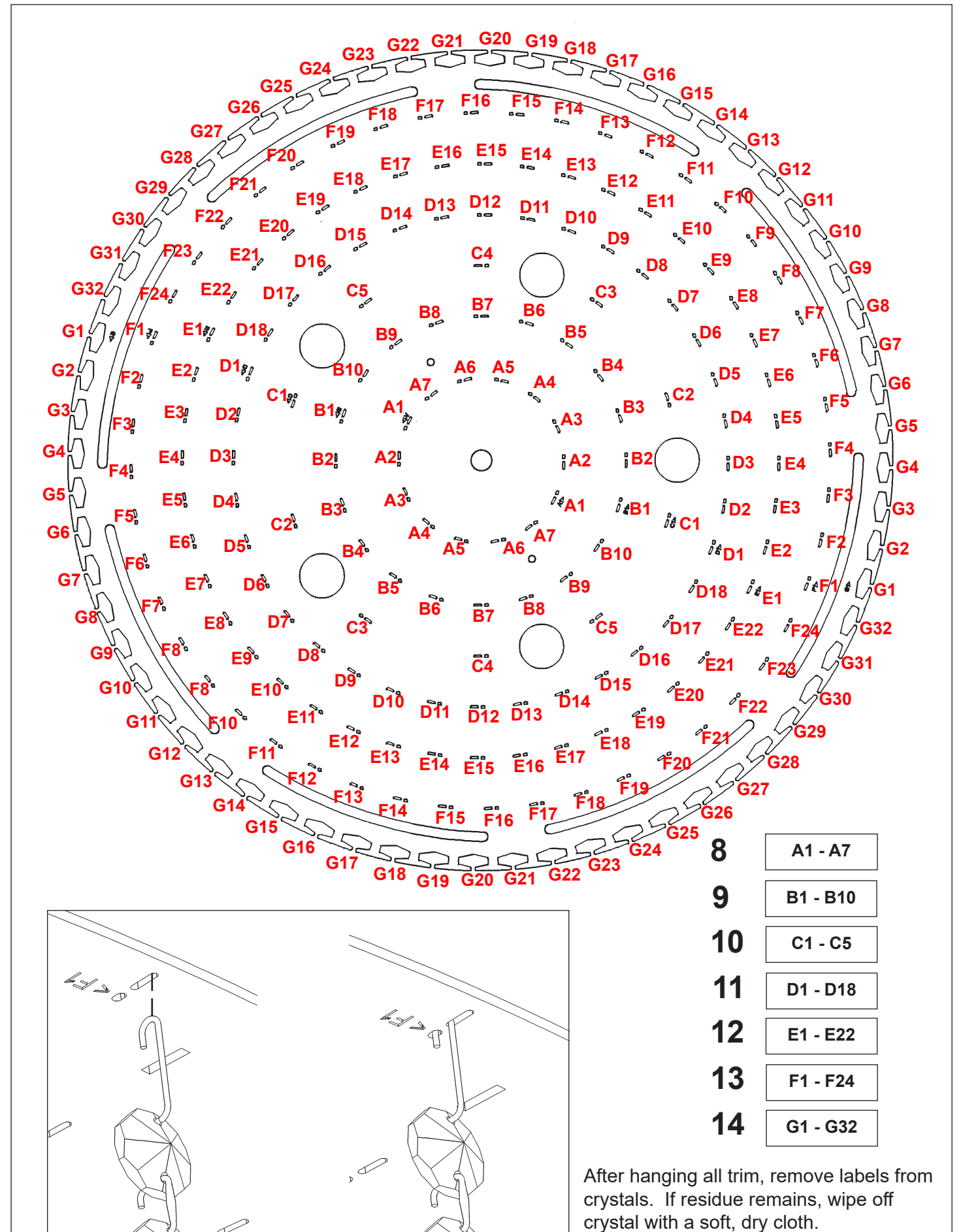

After hanging all trim, remove labels from crystals. If residue remains, wipe off crystal with a soft, dry cloth.